

General Specifications

Electrical Capacity (Resistive Load)

Logic Level: 0.4VA maximum @ 28V AC/DC maximum
(Applicable Range 0.1mA ~ 0.1A @ 20mV ~ 28V)
Note: See Supplement section for explanation of operating range.

Other Ratings

Contact Resistance: 80 milliohms maximum
Insulation Resistance: 500 megohms minimum @ 500V DC
Dielectric Strength: 500V AC minimum for 1 minute minimum
Mechanical Life: 50,000 operations minimum
Electrical Life: 50,000 operations minimum
Nominal Operating Force: 1.6N for momentary & 1.7N for maintained
Angle of Throw: 28°

Materials & Finishes

Actuator: Polyphenylene sulfide (UL94V-0)
Case: Polyphenylene sulfide (UL94V-0)
Sealing Rings: Nitrile butadiene rubber
Movable Contacts: Phosphor bronze with gold plating
Stationary Contacts: Phosphor bronze with gold plating
Base: Polyphenylene sulfide (UL94V-0)
Terminals: Phosphor bronze with gold plating

Environmental Data

Operating Temperature Range: -30°C through +85°C (-22°F through +185°F)
Humidity: 90 ~ 95% humidity for 96 hours @ 40°C (104°F)
Vibration: 10 ~ 500Hz with peak-to-peak amplitude of 1.5mm traversing the frequency range & returning in 1 minute; 3 right angled directions for 2 hours
Shock: 50G (490m/s²) acceleration (tested in 6 right angled directions, with 5 shocks in each direction)

Installation

Mounting: It is recommended that the body of models for upright mounting without bracket be fastened to a panel or similar support for protection of solder joints from mechanical stress.
Coplanarity: See specifications in Terms & Acronyms in Supplement section

Processing

Soldering: Reflow Soldering recommended. See Profile B in Supplement section.
Manual Soldering: See Profile B in Supplement section.
Cleaning: Automated cleaning. See Cleaning specifications in Supplement section.

Standards & Certifications

Flammability Standard: UL94V-0 actuator, case & base
The G3T Series toggles have not been tested for UL recognition or CSA certification. These switches are designed for use in a low-voltage, low-current, logic-level circuit. When used as intended in a logic-level circuit, the results do not produce hazardous energy.

Distinctive Characteristics

Ultra-miniature size allows high density mounting, and extremely light weight of 0.6 gram makes these switches ideal for handheld equipment.

Tape-reel and stick-tube packaging allow rapid automated placement of surface mount devices. Tape-reel packaging meets EIA-481-D Standard.

Heat resistant resin used for housing, base, and lever allows vapor phase and infrared convection reflow soldering.

Combination of design features achieves total seal and allows automated processing techniques, including flux cleaning procedures: one-piece bushing and housing, rubber seals surrounding actuator and base, epoxy at joint of case and base, and molded-in, epoxy-sealed terminals.

Award-winning STC contact mechanism with benefits unavailable in conventional mechanisms: smoother, positive detent actuation, increased contact stability and unparalleled logic-level reliability. (Additional STC details in Terms & Acronyms; see Supplement section.)

Gull-wing terminals provide mechanical stability during soldering and simplified solder joint inspection.

Coplanarity: all considered surfaces must lie between two parallel planes that are a maximum distance apart of .0059" (0.15mm). (Additional coplanarity details in Terms and Acronyms in the Supplement section.)

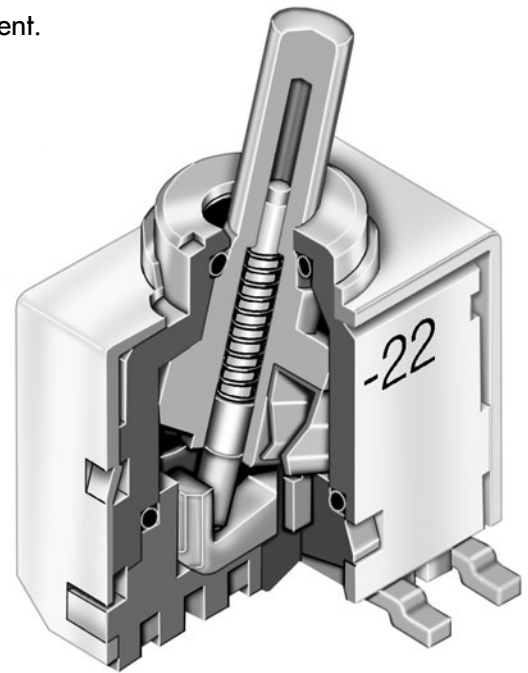

Actual Size

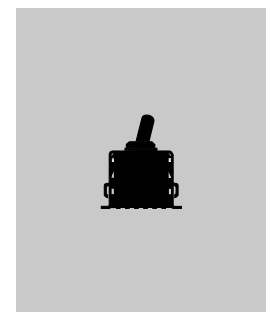

A
Toggles

Rockers

Pushbuttons

Illuminated PB

Programmable

Keylocks

Rotaries

Slides

Tactiles

Tilt

Touch

Indicators

Accessories

Supplement

TYPICAL SWITCH ORDERING EXAMPLE

G3T **1** **2** **A** **H** —

Poles	
1	SPDT
2	DPDT

Actuator	
A	.150" (3.8mm) Column Toggle

Packaging	
R	Tape-Reel for Right Angle Only 500 Pieces/Reel
S	Stick-Tube for Upright Mount 50 Pieces/Stick
No Code	Partitioned Tray for Upright & Right Angle Any Quantity

Circuits			
2	ON	NONE	ON
3	ON	OFF	ON
5	ON	NONE	(ON)
8	(ON)	OFF	(ON)
9	ON	OFF	(ON)

Terminals	
P	Gull Wing for Upright Mount
B	Gull Wing for Upright with Bracket Mount
H	Gull Wing for Right Angle Mount

() = Momentary

Package details at end of G3T Series

DESCRIPTION FOR TYPICAL ORDERING EXAMPLE

G3T12AH



POLES & CIRCUITS

Pole	Model	Toggle Position () = Momentary			Connected Terminals			Throw & Schematics
		Up	Center	Down	Up	Center	Down	
SP	G3T12 G3T13 G3T15 G3T18 G3T19	ON ON ON (ON) ON	NONE OFF NONE OFF OFF	ON ON (ON) (ON) (ON)	5-6	OPEN	5-4	SPDT
DP	G3T22 G3T23 G3T25 G3T28 G3T29	ON ON ON (ON) ON	NONE OFF NONE OFF OFF	ON ON (ON) (ON) (ON)	5-6 2-3	OPEN	5-4 2-1	DPDT

Note: Terminal numbers are not actually on switch.

ACTUATOR

A .150" (3.8mm) Column Toggle

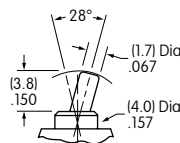

TYPICAL SWITCH DIMENSIONS

A
Toggles

Single & Double Pole

Upright Mounting

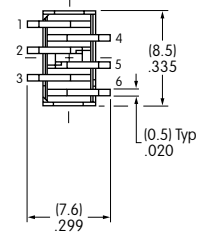
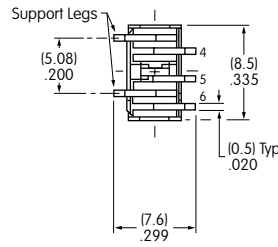
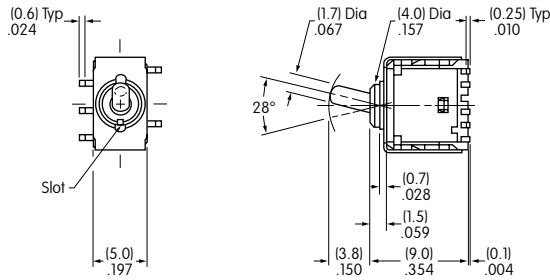

G3T12AP

Rockers

Pushbuttons

Single & Double Pole

Upright Mounting with Bracket

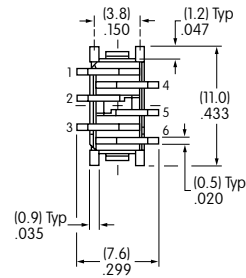
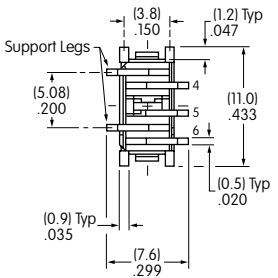
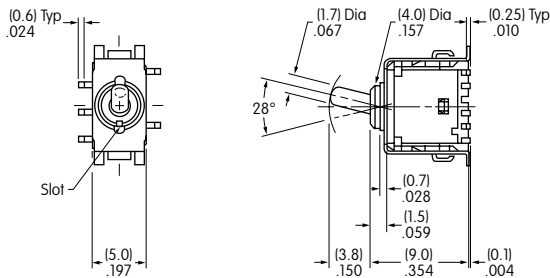

G3T22AB

Illuminated PB

Programmable

Keylocks

Right Angle Mounting

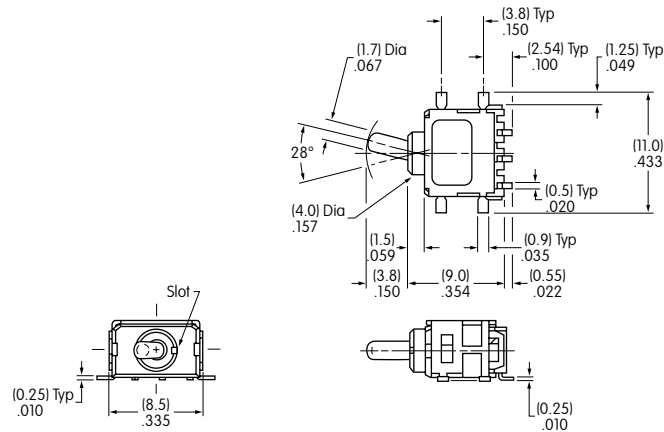

Single Pole

Double Pole

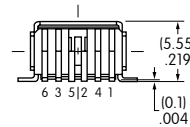
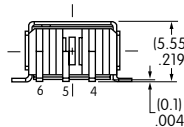

G3T12AH

Rotaries

Slides

Tactiles

Pad Layouts for Surface Mount Terminals

Upright Mounting

Upright Mounting with Bracket

Right Angle Mounting

Single Pole Double Throw

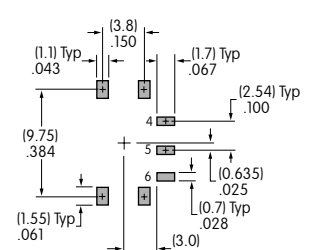
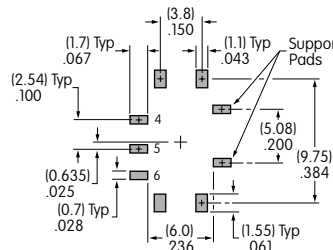
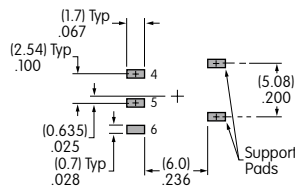

Double Pole Double Throw

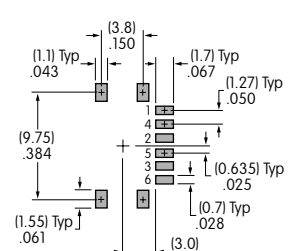
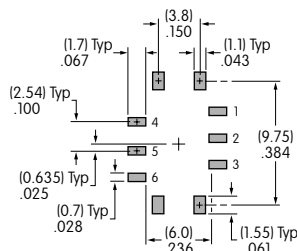
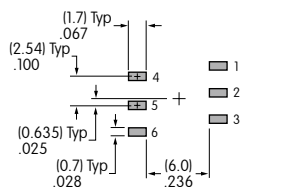

Tilt

Touch

Indicators

Accessories

Supplement

PACKAGING

R Tape-Reel for Right Angle

500 pieces per reel

Switches must be ordered in 500-piece increments when tape-reel packaging is selected.

This packaging meets EIA-481-D Standard for "16mm and 24mm Embossed Carrier Taping of Surface Mount Components for Automatic Handling."



S Stick-Tube for Upright Mount

50 pieces per stick

Switches must be ordered in 50-piece increments when stick-tube packaging is selected.



No Code Partitioned Tray for Upright & Right Angle

Any quantity

If the G3 upright models are ordered in less than 50-piece increments or the right angle models in less than 500-piece increments, the switches are packaged in a partitioned tray. No code is required.



PACKAGING (CONTINUED)

Tape-Reel Packaging for Right Angle Mount

Each tape-reel of 550 pockets contains 500 switches.

Minimum Leader Length: 7.87" (200mm) Minimum Trailer Length: 1.97" (50mm)

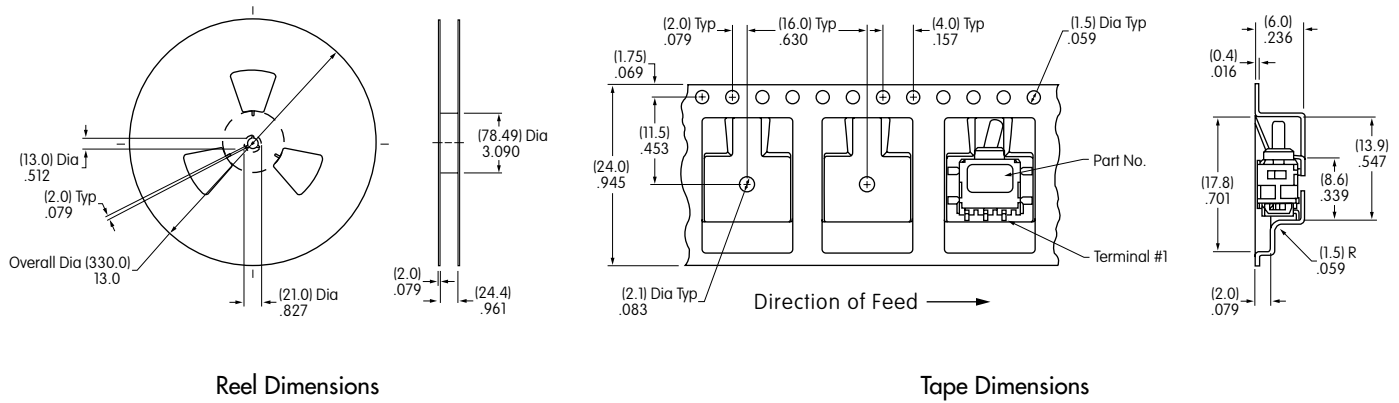

Reel Dimensions

Tape Dimensions

Stick-Tube Packaging for Upright Mount

Each stick-tube contains 50 switches.

L = Length

G3T Upright (code P)
18.31" (465mm)

G3T Upright with Bracket (code B)
21.26" (540mm)

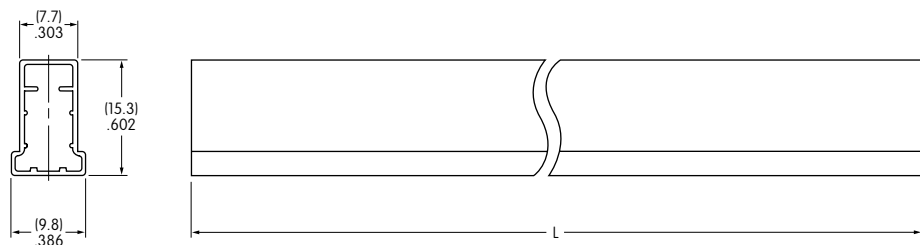

Stick-Tube Dimensions